

AGES 8+
75066

LAZER TAG
TEAM OPS™

TAG MASTER BLASTER™*

Thank you for purchasing the LAZER TAG, TAG MASTER BLASTER™*. Please be sure to read and follow all instructions carefully before using this product.

Includes 1 Tag Master Blaster™* Unit, 1 Lazer Tag Missile™*, Stickers & Instructions.

Requires 6 x 1.5V "AA" or R6 size batteries (not included).

Alkaline batteries recommended. Phillips/cross head screwdriver (not included) needed to insert batteries.

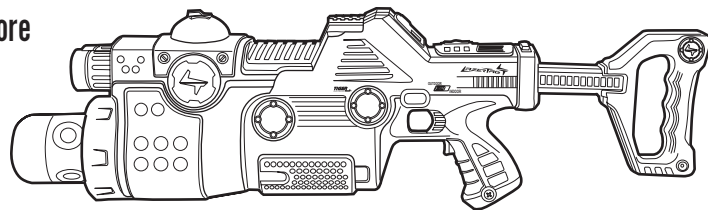

TAG MASTER BLASTER™* is compatible with all LAZER TAG TEAM OPS TAGGER units.



Tiger®* recommends ENERGIZER® batteries for ideal performance.

FIND 12 HIDDEN LAZER TAG [CODES] THROUGHOUT THIS BOOK.

Log-on to lazertag.com and enter your codes to unlock secret bonus game strategies!



CAUTION: Do not aim at eyes or face.
TO AVOID INJURY: Use only missile designed for this product. Do not modify missile or missile launcher.
NOTE: Not for nighttime play.

TABLE OF CONTENTS

Quick Start Guide.....	1	To use Dual TAGGER Units in a game of LAZER TAG	18
Helpful Hints and Introduction	2	Ending the Game in Dual TAGGER Mode	20
Battery Installation Information	3	11 Pre-Programmed Lazer Tag® Games.....	21
Getting to know your TAGGER	4	Classic LAZER TAG	21
TAGGER Unit Illustration	4	Custom LAZER TAG.....	21
TAGGER Buttons	5	2 and 3 Team Customized LAZER TAG	22
LED Feedback Panel/ HIT Indicator/ LCD Screen.....	6	2 and 3 Kings.....	22
LAZER TAG Code Of Conduct.....	7	Hunt the TAG MASTER	23
Using your TAGGER	8	2 Teams vs. the TAG MASTER	23
LAZER TAG Game Features.....	8	TAG MASTER vs. Individual Players	24
How to use the LAZER TAG MISSILE	10	1-on-1	25
Text Messaging	10	Survival.....	25
Naming your TAGGER.....	11	Troubleshooting.....	26
Game Set Up	12	Energizer Coupon.....	27
Programmable Games	12		
To Host a Game of LAZER TAG	12		
To Join a Game of LAZER TAG	15		
End of Game Debriefing and Scoring.....	16		
Ending Games Early.....	18		

QUICK START GUIDE

For a quick, “Grab & Go” game of LAZER TAG simply follow these steps:

1. Press the TRIGGER to wake your TAGGER up.
2. Verify that the power-up SFX are played, and “LTAG” appears on the LCD screen.
3. Press the TRIGGER a second time to start the Classic LAZER TAG “LTAG” game. All players should press their triggers together, so that everybody starts at the same time.
4. The LCD Screen will display a 10-second countdown during which time the players should take their desired positions.
5. At T-0 the TAGGER will say “GOOD LUCK” and the game will begin.
6. Aim and get tagging!

The Classic LAZER TAG game is an “individuals” game, which means that all other players are your opponents. The winner is the last player not tagged out. Each player has unlimited reloads, 15 seconds of shields, and is tagged out after receiving 10 tags from other players.

After a player is tagged out, their Game Timer will continue to run for another four minutes. The tagged-out player may switch between the Game Timer display and the time at which he was tagged-out by using the INC and DEC buttons. Any player who has

cheated by restarting their TAGGER in mid-game will have a much lower Game Time than anyone else, so players can check each others’ timers to ensure no player has done this.

A TAGGER will go to sleep if there is no activity for four minutes after being tagged out. To maintain your game timer longer than this, press OK once a minute or so until the game is over for all players, then you can compare timers.

Classic LAZER TAG is not a Hosted game, so it does not require Hosting and Joining the way the other more advanced games do. It also does not support Debriefing and Scoring at the end of the game.

To turn your TAGGER off, press 2nd F + CANCEL.

If you’d like to start another game, just press the TRIGGER!

IMPORTANT NOTE: If your TAGGER is functioning improperly or stops functioning, try pressing the Reset Button.

HELPFUL HINTS

1. During general use, the Indoor/Outdoor Switch should be set at "Outdoor." If you experience stray or incidental tags when playing in an enclosed area, switch the Indoor/Outdoor switch to "Indoor" to minimize reflective signals.

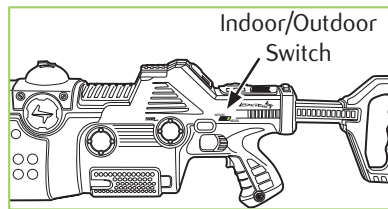

TAGGER LEFT SIDE VIEW

2. There is a sight on the top of the Tagger™ Unit to assist in accurate launching of tags. Line up your target by using the sight for increased accuracy in targeting.

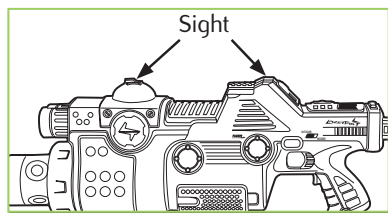

TAGGER LEFT SIDE VIEW

3. Tags can be registered from a distance, even if it exceeds your lock-on and verification capabilities. This means you can sometimes score a long distance tag without audio/visual verification. Even if your TAGGER is not locking on to its target, it is often worth attempting a long distance tag in excess of 400 feet using the manual sight alone.



TAGGER LEFT SIDE VIEW

STICKERS

Several stickers have been included for you to decorate your TAGGER. Please apply the stickers anywhere you like on your TAGGER with the exception of the: LCD screen, IR-LEDs, IFF Beacon/Receiver Dome and the Launching and Receiving Tubes.

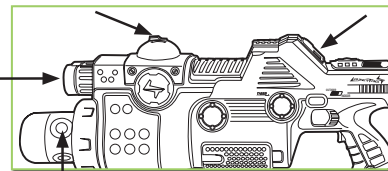

Do not place stickers where arrows are indicating.

NOTE: Stickers are a one-time application.

Thank you for purchasing the LAZER TAG, TAG MASTER BLASTER™! Step into LAZER TAG – where video game action comes to life!™ LAZER TAG combines extreme team competition with hi-tech accuracy. Assemble your team and lead them into The Ultimate Game of Electronic Tag™ to become the Tag Master™!

Please be sure to read and follow all instructions carefully before using this product. Before you can begin playing with your LAZER TAG, TAG MASTER BLASTER™ you must first install batteries.

Be the TAG MASTER!

Think you've got what it takes to be the TAG MASTER? Prove it by being the winner in your first game of LAZER TAG! Earn this title and you will have the privileges of being the host for the next game!

TO INSERT BATTERIES

Using a Phillips/cross head screwdriver, loosen the screw in the battery compartment cover of the TAG MASTER BLASTER (screw stays attached to cover). Remove cover and battery tray. Insert 6 x 1.5V "AA" or R6 size batteries (not included) into tray. Alkaline batteries recommended. Insert tray, replace cover and tighten screw.

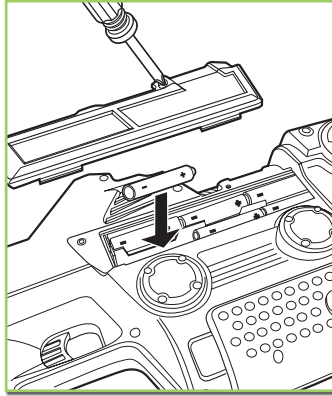

CAUTION: TO AVOID BATTERY LEAKAGE

1. Be sure to insert the batteries correctly and always follow the toy and battery manufacturers' instructions;
2. Do not mix old batteries and new batteries or alkaline, standard (carbon-zinc) or rechargeable (nickel-cadmium) batteries;
3. Always remove weak or dead batteries from the product.

IMPORTANT: BATTERY INFORMATION

Please retain this information for future reference.
Batteries should be replaced by an adult.



CAUTION:

1. Always follow the instructions carefully. Use only batteries specified and be sure to insert item correctly by matching the + and - polarity markings.
2. Do not mix old batteries and new batteries or standard (carbon-zinc) with alkaline batteries.
3. Remove exhausted or dead batteries from the product.
4. Remove batteries if product is not to be played with for a long time.
5. Do not short circuit the supply terminals.
6. Should this product cause, or be affected by, local electrical interference, move it away from other electrical equipment. Reset (switching off and back on again or removing and re-inserting batteries) if necessary.
7. **RECHARGEABLE BATTERIES:** Do not mix these with any other types of batteries. Always remove from the product before recharging. Recharge batteries under adult supervision. **DO NOT RECHARGE OTHER TYPES OF BATTERIES.**

GETTING TO KNOW YOUR TAGGER

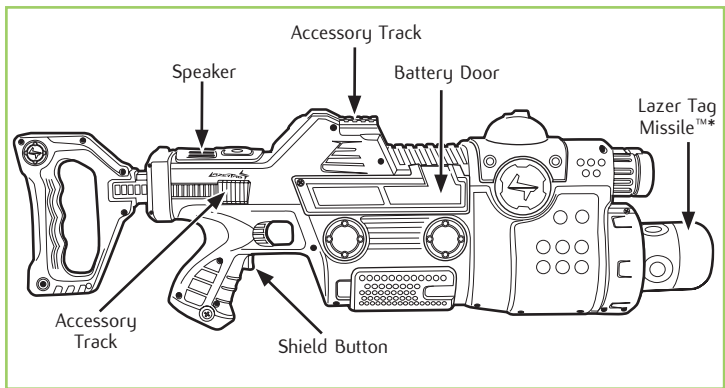

TAGGER RIGHT SIDE

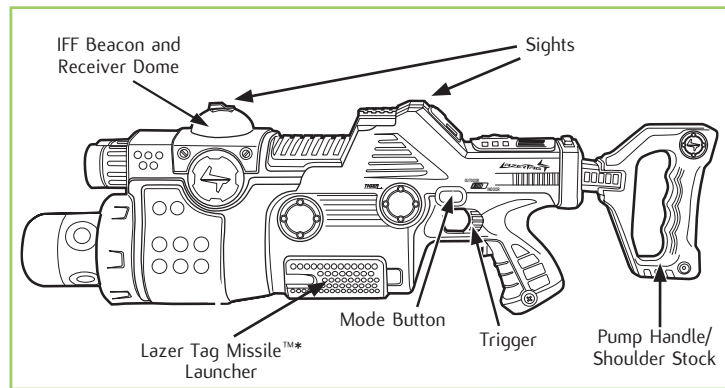

TAGGER LEFT SIDE

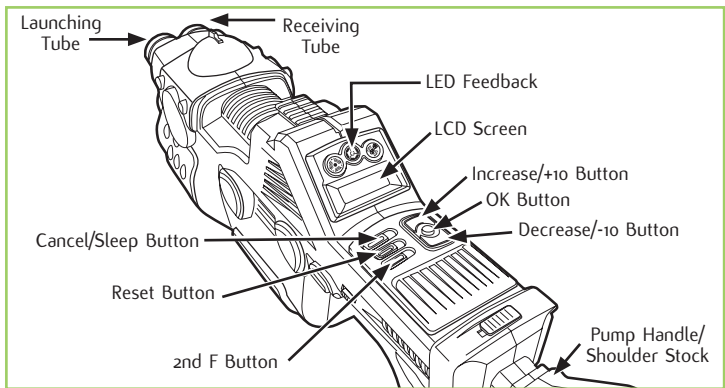

TAGGER REAR VIEW

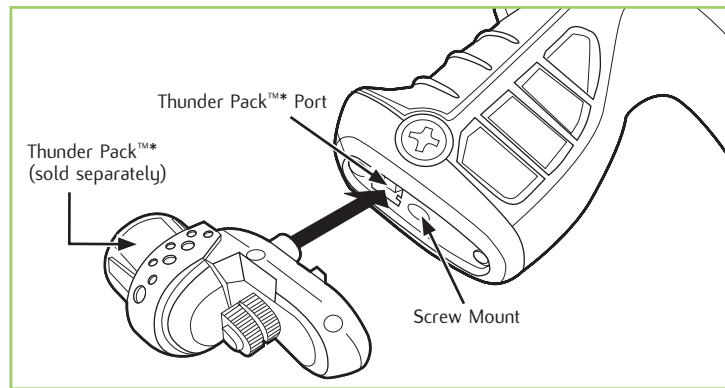

TAGGER BASE

BUTTONS

The following buttons are used to enter information into your TAGGER before, during, and after the game. Each button has two functions: its Main Function and its Second Function. In addition, some buttons such as the INC and DEC do different things during the actual game than they do during the set-up, Hosting/Joining, and Post-Game displays.

TRIGGER

Press the Trigger to wake up your TAGGER or to launch tags.

SHIELD

Press the Shield button to raise and lower your defensive shields.

MODE

The Mode button has three different functions. Hold MODE and press INC or DEC to select a message. Hold MODE and press the TRIGGER to send a text message instead of a tag. Hold MODE and press SHIELD to change your mode of launching tags [Single Shot, 3 Burst Shot, Fully Automatic].

2nd F

Hold this button down and quickly press then release any of the other buttons to perform that button's Second Function. Pressing and holding 2nd F for more than 2 seconds at any time during an actual game mutes or un-mutes the sound effects.

INC

During the game set-up and post-game displays, this will select the next item in a list of options, or increase a number value by 1. Second Function: 2nd F + INC = Increases the number value by 10. During the games, INC changes the in-game data display while 2nd F + INC increases the LCD contrast.

DEC

During the game set-up and post-game displays, this will select the previous item in a list of options, or decrease a number value by 1. Second Function: 2nd F + DEC = Decreases the number value by 10. During the games, DEC changes the in-game data display while 2nd F + DEC decreases the LCD contrast.

OK

Enters the selected option or value. Second Function: 2nd F + OK = Starts or ends the game immediately (only the Host can do this).

CANCEL

Cancels the value or option just selected and backs-up a step. Second Function: 2nd F + CANCEL = Quits the game and turns the TAGGER off during game set-up and post-game displays, and during LAZER TAG games. To cancel a game and turn the TAGGER off in the middle of a game, you must hold the SHIELD button and TRIGGER while holding 2nd F and pressing CANCEL.

LED FEEDBACK PANEL

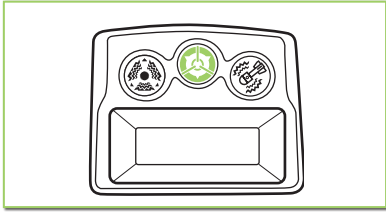

GREEN: LOCKED-ON to another player.



YELLOW: TAGGED another player.

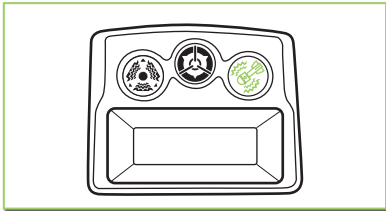

RED: READY to launch LAZER TAG MISSILE.

HIT INDICATOR

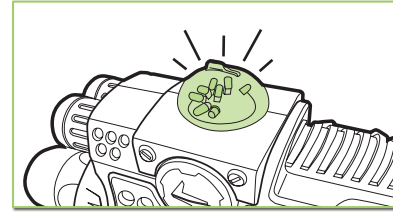

TAGGED by another player.

LCD SCREEN

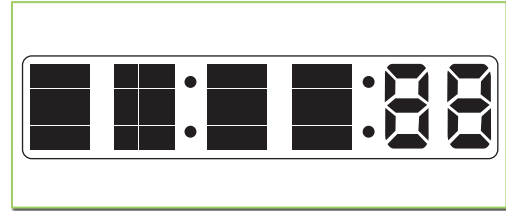

Alpha-Numeric Display

LAZER TAG® CODE OF CONDUCT

LAZER TAG Players follow a strict code of conduct when playing Lazer Tag. The following is the Official Lazer Tag Code Of Conduct that should be strictly adhered to in every game of Lazer Tag.

Rule 1: Lazer Tag is a non-contact sport

This means no physical contact between you and other players – EVER!

Rule 2: No covering the Receiver Dome

This means do not use anything to cover up the Receiver Dome thereby preventing you from receiving tags. If you want to avoid being tagged, you must use your defensive shields or take cover behind something.

Rule 3: Equipment Failure means Disqualification

In the event that your TAGGER fails to work, you are disqualified and must wait until the end of the game to join the next one. Please check your TAGGER carefully before entering a game to ensure that it is working properly.

Rule 4: Lazer Tag is a Game

Players must remember that Lazer Tag is only a game. It is designed purely for recreational use and for fun. Not having fun is against the code.

Rule 5: Lazer Tag is a Team Sport

Although Lazer Tag is a highly competitive sport, in many of the games you must consider the success of the team first. Players will win and lose as teams, not individuals. There's no "I" in "TEAM!"

USING YOUR TAGGER

LAZER TAG GAME FEATURES

- **Lock-On** – The green LED light on the LED Feedback Panel will light up to indicate that there is another player in your sight. Tag your opponent when you are locked-on.
- **IFF** – (Identification, Friend or Foe) You will hear the sounds “bee-beep, bee-beep” if the player you are locked-on to is someone you should be tagging (your enemy), or “poonk, poonk, poonk” if they are someone you should not be tagging (your teammate).
- **Proximity** – You will hear “Danger” if an enemy is nearby.
- **Reloads** – Your TAG MASTER BLASTER has an Automatic Reload feature so there is no need to worry about reloading! You cannot launch tags while reloading, but you can raise shields to avoid being tagged.
- **Shields** – You can raise defensive shields, lasting up to 10 seconds each by pressing the SHIELD button once to raise the shield and again to lower the shield. When your shields are raised, your opponents cannot tag you, you cannot launch any tags, your LAZER TAG MISSILE becomes inactive, and no other player can get a lock-on to you or any IFF info about you. When shields are raised “SHLD” is displayed along with the maximum number of seconds left in the shield. There is a mandatory 2-second cool down period between lowering and raising your shield again, during which the TAGGER displays “SHDS:” and the total number of shields seconds left in the game.

- **Single Shot vs. 3 Burst Shot vs. Fully Automatic** – The TAG MASTER BLASTER features three distinct ways of launching tags at your opponent. Press and hold the MODE Button while pressing the SHIELD Button to cycle through the three modes (the LCD Screen will display the selected mode). Simply let go of the SHIELD Button then the MODE Button when you have reached your selection and that’s the mode you’ll be in. Select “SNGL” for Single Tags, “BRST” for 3-Tag Bursts, or “AUTO” for Fully Automatic. In “SNGL” mode, when you tap the TRIGGER once you’ll launch a Single Tag, in “BRST” mode when you hold down the TRIGGER you’ll launch a rapid three tag burst, or in “AUTO” mode when you hold down the TRIGGER you’ll launch tags non-stop at your opponent until you need to reload.
- **T-Minus** – The counter that counts down to start a game.
- **Team Tags** – The Host can choose whether tags from your own teammates will or will not affect you. Make sure you ask whether the TAG MASTER has selected Team tags or not! Tagging members of your own team counts against your ranking at the end of the game and in some games can hurt your team’s ranking as well.
- **Alternate Displays** – You can select which game data you want to have displayed during the game by using the INC and DEC buttons.
 - Game Timer with Tags-Until-Reload: (F = Full = 10 tags left until reloading)
 - HITS LEFT: Number of tags left until you are tagged out (displayed as: HITS: 52 for 1-99, or 179 HL for numbers over 99)
 - SHDS: Seconds of shield time you have left

- **LOADS LEFT:** Number of reloads you have left (displayed as: RLDS: 10 for 1-99, or 245 LL for numbers over 99).
 - **ID:** Your team (if any) and Player Number
 - **HIDE or SEEK:** What you should be doing in a Hide and Seek game (can only be hosted on Deluxe TAGGER units)
 - **HUNT:** Team you are supposed to be hunting in a Hunt the Prey game (can only be hosted on Deluxe TAGGER units)
 - **LT:** Player ID of last player to tag you
 - **Z:** Accumulated Zone Time
- **Pop Up Displays-** During the course of the game, important messages about the game may pop up momentarily on your screen, temporarily overriding your selected display. These are to alert you to such things as becoming neutralized or overheated, or how many tags you have left if you have just taken a tag and are getting near the end of your game.
 - **Team and Player Ranking** – At the end of all games except Classic LAZER TAG, the performance of each team and individual player is ranked against all others in the game.
 - **Head-To-Head Scoring** – All games except Classic LAZER TAG support head-to-head score comparisons after the rankings are done. Each player can see how many times he or she tagged another player and was tagged by another player.
 - **Mute** – The sound effects may be turned on or off by pressing and holding the 2nd F button for 2 seconds once the game is going – there

will be one “beep” to let you know when the key has been recognized, and after that there will be no more sound effects until the game ends or you press and hold 2nd F for another 2 seconds.

- **Contrast/Brightness** – You can adjust the brightness (darkness) of the LCD screen during the game by holding 2nd F and pressing INC or DEC. Remember not to hold 2nd F for too long, or the TAGGER will think you are muting the sound effects.
- **Sleep** – You can quit out of a game during the game hosting/joining process, during debrief and results, and at any time during an LTAG game, by holding 2nd F and pressing CANCEL. The TAGGER will go to sleep and the game will be lost. The LCD screen will scroll www.lazertag.com before shutting down.

NOTE FOR HOSTED GAMES: Until the time expires or the game is called off early by the Host, you must hold 2nd F and press CANCEL while holding down the TRIGGER and SHIELD at the same time in order to put your TAGGER to sleep (this prevents accidental shut-off).

Do NOT turn your TAGGER off during hosted games, or you will be dropped from the game and the remaining players’ scores may be

HOW TO USE THE LAZER TAG MISSILE

The LAZER TAG MISSILE can soar over 40 feet and upon impact sends out tags to any opponent within a 15 to 20 foot radius. The closer the LAZER TAG MISSILE lands to them, the more tags they will take!

Aim carefully because if you accidentally hit an unintended object (like a wall), the tags from the LAZER TAG MISSILE could ricochet back and hit you (and any of your teammates if the Team Tags feature is enabled)!

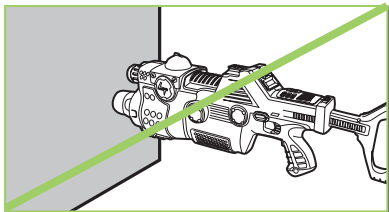

1. Using the pump handle, pump the blaster 10 to 20 times to pressurize.

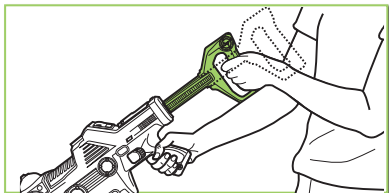

2. Slide the LAZER TAG MISSILE fully into place, as shown.

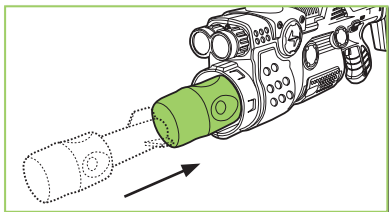

3. Wait for the red LED indicator light to come on (approximately 3-5 seconds). Then you'll hear "Rocket Ready!" When this happens, the LAZER TAG MISSILE is charged.

4. Pull the LAZER TAG MISSILE Launcher back quickly to launch the LAZER TAG MISSILE.

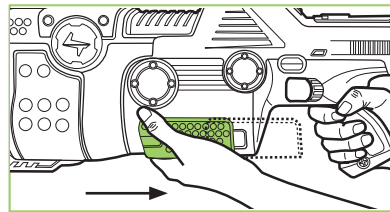

5. For better aim during play, extend and lock shoulder stock into place. To do this, pull back the shoulder stock to desired length and move lock button to the right to lock into place.

Move the lock button to the left to unlock and readjust the length of the shoulder stock.

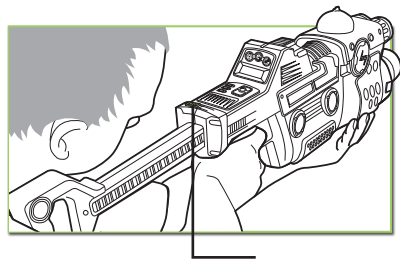

TEXT MESSAGING

Your TAG MASTER BLASTER TAGGER is equipped with a text message feature enabling you to send messages to your teammates or opponents during a game. You can send your opponent a message when you've tagged them or send a separate message to a teammate. Messages can be up to 10 characters long.

Your TAG MASTER BLASTER TAGGER is equipped with a text message feature enabling you to send messages to your teammates or opponents during a game. You can send your opponent a message when you've tagged them or send a separate message to a teammate. Messages can be up to 10 characters long.

Press the TRIGGER to wake up your TAG MASTER BLASTER and enter the Main Menu. In the Main Menu, use the INC or DEC buttons to select the TEXT option and press OK to begin editing the text message.

Use the following buttons to write and send your text message:

- INC and DEC = Use to select a character to add to the message
- OK = Use to add that character to the message
- CANCEL = Use to erase the last character from the message

Once the text message is complete and correct, press 2nd F + OK to store it for future use in a game. Or, press 2nd F + CANCEL to abandon the changes and leave the message the way it was.

To send a text message during a game, hold the MODE button and use the INC and DEC buttons to scroll through the available preset messages.

They are:

- HAHA = Ha Ha!
- GTCH = Gotcha!
- SEEU = I See You!
- GLFT = Go Left!
- GRGT = Go Right!
- LLFT = Look Left!
- COME = Come Here!
- OKAY = Ok
- ZONE = Go 2 Zone!
- MESG = Your own customized message (up to 10 characters). If you want to send your name, enter it here.

LRGT = Look Right!

COVR = Cover Me!

Press OK while still holding the MODE button once the message you want to send is displayed.

When you release the MODE button, the LCD screen will return to normal, but your text message will be waiting to be sent the next time you press the TRIGGER, without holding the MODE button. If you selected this mode by mistake, press CANCEL while holding the MODE button.

If you want to launch a tag followed by the text message, press the TRIGGER.

If you want to send your text message without launching a tag, hold down the MODE button and press the TRIGGER.

NOTE: When sending a text message, you must hold your TAG MASTER BLASTER on the intended target for at least 1 second to ensure the

NAMING YOUR TAGGER

Press OK to begin editing the name on your TAGGER.

Use the following buttons to write your name (up to 10 characters):

- INC and DEC = To select a letter
- OK = To add the selected letter
- CANCEL = To erase the last letter entered

Once your name is complete and correct, press 2nd F + OK to store it.

Press 2nd F + CANCEL to abandon the change and leave your name as is.

GAME SET UP

PROGRAMMABLE GAMES

Be the TAG MASTER!

Think you've got what it takes to be the TAG MASTER? Prove it by being the winner in your first game of LAZER TAG! Earn this title and you will have the privileges of being the host for the next game!

All of the games except LTAG (Classic LAZER TAG) require the game options to be programmed by the TAG MASTER. Any player can be the TAG MASTER, but there is only one per game. Once the TAG MASTER has programmed all of the game options into his/her TAGGER, it will automatically transfer the options to all of the other TAGGER units as they join the game (these players are called Joiners). The TAG MASTER will have exactly the same powers and abilities as all of the other Joiner Players in the game, except for in the TAGM, 2TTM, and TMIG games (see pages 23 to 24) in which the TAG MASTER has more reloads and hits-until-out than each of the other players.

All programmed games run for a given time (programmed by the TAG MASTER). Once the game ends, all players bring their TAGGER units together with the TAG MASTER TAGGER, which automatically "debriefs" them. The TAG MASTER TAGGER learns how well each player did in the game, and then automatically ranks all players and teams, so that each player can see how well they did as compared to the other teams and players in the game.

NOTE: When setting up to Host or Join a game, and during Debriefing, please make sure to hold all TAGGER units at similar heights, pointed slightly downward. If possible, all players should stand in a circle each approximately 6 feet from the TAG MASTER while facing the TAG MASTER.

NOTE: Deluxe and IRT-2X TAGGER units can play all of the games described in this booklet. TAG MASTER BLASTER TAGGER units can play in all of the games that the Deluxe and IRT-2X TAGGER units host. However, please note that different TAGGER units have different capabilities, so not all special modes are available in all TAGGER units.

TO HOST A GAME OF LAZER TAG

1. Press the TRIGGER to wake up your TAGGER.
2. The TAGGER will make a power-up sound and then display the Main Menu which has seven options:
 - LTAG – Play a basic Grab & Go game of Classic LAZER TAG.
 - JOIN – Join a game Hosted by another player.
 - DUAL – Enter into a Hosted game as a Dual TAGGER.
 - HOST – Be the TAG MASTER and host a game for other players to join.
 - NAME – Name your TAGGER.
 - TEXT – Enter a text message to send to targeted players.
 - QUIT – Return to "sleep" mode.



3. Use the INC and DEC buttons to scroll to HOST and press OK.

You are now in the Host Menu where you will have the following 11 game options to choose from:

- CUST – customized game for individual players
- 2TMS – customized game for 2 teams
- 3TMS – customized game for 3 teams
- 2KNG – Kings game for 2 teams
- 3KNG – Kings game for 3 teams
- TAGM – Hunt the TAG MASTER game for 1 team vs. the TAG MASTER
- 2TTM – Hunt the TAG MASTER game for 2 teams vs. the TAG MASTER
- TMIG – TAG MASTER versus individual players
- 1ON1 – One-on-One Offense game for 2 teams
- SURV – Survival game for individual players
- LAST – Once a game has been successfully modified and hosted, it is stored here. You may recall and re-host it with all of its custom settings in-place.



“Individual players” means the players are not divided into teams, it’s “every player for his or herself.” All Hosted games must have at least 2 players.

4. Use the INC and DEC buttons to scroll through these options to the game you want and press OK. Now it’s time to configure the selected game:

- TT: Y or N – Team tags, yes or no. Decide whether tags from players on your team do (Y) or do not (N) count against you. (Only for team games.)
- MM: Y or N – Medic Mode, Yes or No. Decide whether players on a team can (Y) or cannot (N) assist their teammates by transferring some of their remaining tags to their teammates. (Only for team games.)
- TIME: <##> –Time limit for the game, in minutes. This can be anywhere from 1 to 99 minutes.
- RELD: <##> – Number of reloads available for each player. Each reload gives you 10 additional tags. This value can be anywhere from 0 to 99, or unlimited (“UL”).
- MEGA: <##> – Number of Mega-Tags available for each player. This value can be anywhere from 0 (no Mega-Tags allowed) to 99, or unlimited (“UL”), but can never be greater than the total number of tags.
- SHLD: <##> – Total seconds of shield time available for each player. This value can be anywhere from 0 (no shield time allowed) to 99 seconds.
- TAGS: <##> – Number of Tags each player can take until they are tagged out. This can be any number from 1 to 99.

NOTE: TAG MASTER BLASTER TAGGER units cannot generate Mega-Tags and cannot request nor assist in Medic Mode transfers. These options allow the Host to define whether or not other types of TAGGER units, such as the Deluxe TAGGER, will be allowed to use these special modes of theirs during the game. Mega-Tags are not allowed in the SURV game, so the MEGA <##> option will not be displayed.

5. Program the functions for the game using the INC and DEC buttons to increase or decrease the value or to switch between Y and N. You may also hold down the 2nd F button and press INC or DEC to increase or decrease the value by 10. If you want to select "UL," it is located just below 00 or just above 99. Once you have adjusted each value to your desired amount, press OK to select that value and move on to the next option to be adjusted.

If you need to go back and change something, you can press CANCEL to back-up through the options until you get to the one that you want to change. All the other options that you have already set will remain programmed, so you can simply press OK to keep the programmed value.

Once you have set the number of TAGS (the last option), the screen will display: "IN:" with a number, and will begin making a sound effect. This sound effect indicates that the TAG MASTER will start joining other players into the game. The number is the total number of players who are now in the game, including the TAG MASTER.

The TAG MASTER needs to wait until all players have successfully joined the game before starting the game. Once at least 2 players are in the game, the T-Minus countdown will begin automatically if additional players do not successfully join the game for a 60-second period. The TAG MASTER can delay the automatic start of the T-Minus countdown by pressing OK at any time to restart the 60-second timer. Alternatively, the TAG MASTER can start the game immediately at any time after at least 2 players are in the game by pressing 2nd F and OK.

6. The T-Minus countdown runs for 30 seconds before the start of the game and is used to allow all TAGGER units in the game to synchronize their Game Timers. The TAG MASTER's LCD screen will count down from "T-30," "T-29," "T-28" etc. (for individual games) or "T1: T-30," "T1: T-29," "T1: T-28" etc. (for team games) and beep each time to alert the players, until it reaches T-00 at which point the TAGGER will say "GOOD LUCK!" and the game begins! All Joiner players must remain close to the TAG MASTER during this countdown until their screens also begin displaying the T-Minus countdown. The TAG MASTER should remain in one place until all other players have begun the T-Minus countdowns on their own screens, at which time the TAG MASTER is free to take up his/her initial position.

NOTE: Once the TAG MASTER TAGGER begins the Joining process, the game is set and cannot be modified. To terminate the game before it has begun, all players must hold their 2nd F buttons and press CANCEL to put their TAGGER units to sleep.

TO JOIN A GAME OF LAZER TAG

NOTE: In order to join a game, the Joiner TAGGER must remain physically close to the TAG MASTER (within 10 feet) until your TAGGER starts the T-Minus countdown.

NOTE: It may take some time for each Joiner to enter the game, as the TAG MASTER registers players one at a time. Please join games one at a time otherwise the TAG MASTER TAGGER may get overloaded with information and it will take longer to begin a game.

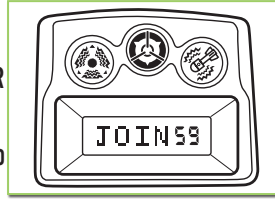

1. Press the TRIGGER to wake up your TAGGER.
2. The TAGGER will make a power-up sound and then display the Main Menu which has seven options:
 - LTAG – Play a basic Grab & Go game of Classic LAZER TAG.
 - JOIN – Join a game Hosted by another player.
 - DUAL – Enter into a Hosted game as a Dual TAGGER.
 - HOST – Be the TAG MASTER and host a game for other players to join.
 - TEXT – Enter a text message to send to targeted players.
 - NAME – Name your TAGGER.
 - QUIT – Return to “sleep” mode.

3. Use the INC and DEC buttons to scroll to “JOIN” and press OK. The LCD screen will display “WAIT” as it waits for instructions from the TAG MASTER, and will display a countdown to show how many seconds are left to join the game. If you were not able to join the game in the allotted time, your TAGGER declares a failure to join the game by playing a sound effect and displaying “NO GAME” in the Text Read-Out.
4. Upon communication with the TAG MASTER, the joining TAGGER will receive the game set-up information. For individual games the TAG MASTER will control all game set up automatically. Skip to Step 6 for individual games.
5. For games with teams, your LCD screen will display “TEAM: .” prompting you to select a team. Select your desired team by pressing the INC and DEC buttons and then OK. If you do not care which team you join, select “-” then press the OK button and the TAG MASTER will assign you to the team with the fewest players, in order to keep the teams even.

NOTE: The team you are assigned to may be different from the team you requested. The TAG MASTER TAGGER will attempt to honor all team requests, but it cannot assign more than 8 players to any given team. Players should discuss who will be on which team, before the game is set up by the TAG MASTER. In the TAGM and 2TTM games, player may not join Team 1 – the TAG MASTER is alone on this team.
6. When the Joiner enters the game the LCD screen will display “IN!” for 2 seconds, then show your Team and Player number. Use this information to determine who your teammates are.

7. It is VERY IMPORTANT that you remain near the TAG MASTER TAGGER. If you wander away from the TAG MASTER TAGGER, your TAGGER will prompt you to “FIND HOST.” If you do not return to the vicinity of the TAG MASTER within 60 seconds, you will be dropped from the game and your LCD screen will show “FAIL.” You must then either re-join the game (receiving a new Team and Player ID) or sit out this game.
8. Once all players have joined the game, the TAG MASTER TAGGER will enter the T-Minus countdown screen. The TAG MASTER’s LCD screen will count down from “T-30,” “T-29,” “T-28” etc. (for individual games) and “T1: T-30,” “T1: T-29,” “T1: T-28” etc. (for team games) and beep each time to alert the players, until it reaches T-00 at which point the TAGGER will say “GOOD LUCK!” and the game begins! It is VERY IMPORTANT that you remain near the TAG MASTER TAGGER until your own LCD screen begins displaying the T-Minus countdown. Once your screen starts the T-Minus countdown, you can safely go to your starting position and/or program your secondary TAGGER if you are using Dual TAGGER Mode. When the T-Minus countdown reaches “T-00” the game will start automatically, and will run for the selected number of minutes.

END OF GAME DEBRIEFING AND SCORING

The game ends and the debriefing process begins when the game timer runs out. If you are tagged out before the game ends, your TAGGER will continuously display “WAIT FOR GAME OVER” alternating with the time left until the game ends.

When the game ends, your TAGGER will first perform un-DUALing if needed (see pages 18 to 20), and will then display “GAME OVER” and then constantly prompt you to “FIND HOST.” You now have 2 minutes to return your TAGGER to the TAG MASTER in order to be debriefed. You must then remain within 10 feet of the TAG MASTER until the Debriefing process is complete in order to receive your ranking. Because of the 2-minute time limit for returning to the TAG MASTER, all players should reach an agreement before the game starts about where they will meet for the debriefing, so that there is no confusion. If you cannot make it back to the TAG MASTER TAGGER within the 2 minute time, press the TRIGGER on your TAGGER approximately every 30 seconds as you return so that your TAGGER will not give up and declare a debrief failure.

During the debriefing process, the TAG MASTER screen will prompt the TAG MASTER to find each of the other players in turn by displaying “?” with the ID of the desired player while waiting approximately 3 seconds to contact that unit. If the Player’s TAGGER is present, the TAG MASTER will automatically download all of the score information and will use it to calculate how he/she and their team did in the game. If a player is slow in getting to the debriefing, the TAG MASTER can temporarily skip over

him/her by pressing OK to move on to the next Player's TAGGER to be debriefed. This also restarts the 2-minute timer, allowing more time for distant players to return and be debriefed. The TAG MASTER will eventually come back to the skipped TAGGER automatically and debrief it. If a player has quit the game, reset their TAGGER or put their TAGGER to sleep (so that their data cannot be gathered), the TAG MASTER can press CANCEL while their ID is displayed to drop that player from the game. This should only be done as a last resort, because all tags which that player landed on the other players will count against the other players, but those same other players will not get credit for any tags they landed on the missing player. In addition, the loss of that player may count against the player's team.

When the debriefing is complete, the TAG MASTER will upload the rankings for each player and team to all the TAGGER units automatically. All player



LCD screens will display various different options (press INC and DEC to switch between them)

- PRNK – How you personally ranked in the game
- TRNK – How your team ranked in the game (only for games with teams)

- Z – Your final Zone Time (Zone games only – must be hosted by other types of TAGGER units)
- O – The time at which you were tagged out (the ending time of the game if you were never tagged out)
- ID: – What your player and team numbers are
- VS – View a head-to-head comparison of how you did versus each of the other players in the game. To enter this display mode, press OK then use the INC and DEC buttons to select which opposing player you want to see data for. Each other player in the game is shown as “TxPy” (Team X, Player Y on that team), or just “P: xx” (Player XX) if there were no teams. Press OK to request this data from the other player's TAGGER and display it in a scrolling message on your screen – if your TAGGER cannot get the data from the other TAGGER in time, it will display “??” instead of a number for how many times you tagged them – you can request the information again later when the other player's TAGGER is closer by or not so busy. If you need to get out of the “VS:” display, you may press CANCEL and you will be back in the Player ID screen.

ENDING GAMES EARLY

All Hosted games will normally end at the programmed time limit. However, the TAG MASTER can declare an early end to the game by holding 2nd F and pressing OK. The TAG MASTER will then immediately end his/her own game, proceed to un-DUAL if needed, and then begin debriefing any players nearby. All players must be called to come to the TAG MASTER within 2 minutes, or the TAG MASTER will count them out of the game and they will receive no score – so make sure everybody knows that you are calling an early end to the game.

Any player who was not yet tagged out at the time the game was called early will be considered to have not been tagged out in the game.

TO USE DUAL TAGGER UNITS IN A GAME OF LAZER TAG

In Dual TAGGER mode you get to use two TAGGER units at the same time! This allows you to engage two opponents in different directions at once and still get the correct score and rankings!

NOTE: In Dual TAGGER mode you can either use two TAG MASTER BLASTER TAGGER units or one TAG MASTER BLASTER TAGGER and one IRT-2X TAGGER (sold separately).

Select one TAGGER to be your primary TAGGER and Join or Host the game with it as you normally would. Then select another TAGGER to use as your secondary TAGGER. This secondary TAGGER enters the game in a special way, so that it does not take up a Player ID for itself but instead uses the same ID as the primary TAGGER.

1. Press the TRIGGER to wake-up the secondary TAGGER, and verify that it generates a sound effect and displays “LTAG” on the LCD screen.
2. Use the INC and DEC buttons to scroll to DUAL, then press OK.
3. Your secondary TAGGER will now display “WAIT” and a countdown while it listens for the game definition from the TAG MASTER TAGGER. Once this information is received, your secondary TAGGER will display the name of the game being hosted (“2TMS” for example). If your secondary TAGGER does not hear the game definition within 60 seconds, the secondary TAGGER will display “NO GAME” and will cancel the process.

After receiving the game definition, if you wander away from the TAG MASTER TAGGER your secondary TAGGER will begin making an alert sound and display “FIND HOST.” If you remain away from the TAG MASTER TAGGER

for more than 60 seconds, your secondary TAGGER will display “FAIL” and will cancel the process.

Once the T-Minus countdown begins and is received by your secondary TAGGER, its LCD will display “PRG –” and the T-Minus countdown time. This indicates that it is time for the DUAL TAGGER to be programmed with the primary TAGGER unit’s Player ID. To do this:

1. Turn your back to the Host and walk approximately 20 feet away from all other players.
2. Point both TAGGER units down at a light-colored spot just in front of your feet, or on a wall approximately 2 feet away.
3. Press the TRIGGER on the primary TAGGER.

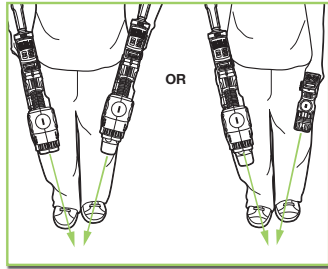

The primary TAGGER will make a “woo-woo-whoop” sound effect to indicate that it is synchronizing with the secondary TAGGER. You will then hear the secondary TAGGER make a “ta-dah” sound effect, and both TAGGER units will display the T-Minus countdown, to indicate that the synchronization has been completed successfully.

If you hear an error sound, like a buzz, and your secondary TAGGER unit’s screen is displaying “???” with a countdown, it means your secondary TAGGER became confused and your two TAGGER units are not synchronized. To redo the synchronization process do the following:

Continue to point both TAGGER units down at the spot just in front of your feet, or at the same spot on a wall approximately 2 feet away. The

secondary TAGGER will soon display either the T-Minus countdown (if it is able to synchronize by itself) or else return to the “PRG-” display if it fails to synchronize. In this case:

- a. Press the TRIGGER on the primary TAGGER again.
- b. Repeat every 2-3 seconds until successful.

NOTE: If the TAG MASTER TAGGER is to be used in Dual TAGGER Mode during a game, you must wait until the T-Minus countdown reaches T-20 or less before you can program your secondary TAGGER. This is to allow all of the other players time to receive the T-Minus countdown from the TAG MASTER TAGGER before it has to divert its attention to programming a secondary TAGGER.

NOTE: The Player ID does NOT appear on the secondary TAGGER in Dual TAGGER Mode until synchronization/programming has been completed successfully.

Once you have successfully programmed your secondary TAGGER, you will begin the game in Dual TAGGER Mode! Each of your TAGGER units has half the number of reloads and half the number of tags it can take until being out of the game, but you can engage twice as many opponents at the same time!

In addition, you can continue to launch tags from one while the other is reloading, and if you practice launching alternating bursts of tags from the two TAGGER units you will be able to keep up a constant barrage of tags without ever overheating. Each of your TAGGER units will have the same game time and shields as any other player in the game. But be careful – a well-placed tag from one of your opponents just might hit BOTH of your TAGGER units, counting as TWO hits against you!

NOTE: If your secondary TAGGER becomes confused during programming and every attempt to synchronize fails, or if you change your mind and never attempt to program it with the primary TAGGER ID, the LCD screen on the secondary TAGGER will display “NO GAME” and will go to Sleep. However, the primary TAGGER will be able to play in the game and will have a full set of capabilities for the game, just as if you had not been using Dual TAGGER Mode.

NOTE: You cannot use Dual TAGGER Mode if you are a King in a 2KNG or 3KNG game or if you are the TAG MASTER in a TAGM, 2TMM, or TMIG game. This is to prevent cheating by hiding one or the other of the two TAGGER units so that you could never be tagged-out, which is the basis of the scoring for these types of games.

ENDING THE GAME IN DUAL TAGGER MODE

Once the game has ended, the data from your two TAGGER units must be combined before reporting back to the Host. This process, called “un-DUALing” is automatic but may require you to take steps to ensure it can happen without interference from other nearby TAGGER units.

The primary TAGGER will display “UNDL” and the secondary TAGGER will display “WAIT.” Step 20 feet away from all other TAGGER units, turn your back to them, and hold both of your TAGGER units side-by-side in front of you. After a few seconds, the Dual TAGGER will go to Sleep and the primary TAGGER will display “FIND HOST.” At this point, continue to follow the debrief process as usual.

NOTE: If any player enters the game in Dual TAGGER Mode, but does not un-DUAL properly within 30 seconds after the end of a game, he/she will be treated as though they abandoned the game. In this case, the player will not receive a personal score and their “abandoning” of the game may count against their team – so be sure that you un-DUAL properly at the end of each game!

If the Host used the Dual TAGGER Mode themselves, the Host must first un-DUAL themselves and then debrief all the other players.

If the game is to be ended early by the Host pressing 2nd F + OK, the TAG MASTER TAGGER must first un-DUAL if needed. Once this is done, all other players need to come within the vicinity of the TAG MASTER TAGGER one at a time and receive the command to end their games early. Once each player’s TAGGER units have ended their game (their primary TAGGER will display “UNDL” and their secondary TAGGER will display “WAIT”), that player must then leave the area of the Host temporarily so that the un-DUALing process can occur without interference, as described above. Once that has happened, the primary TAGGER will display “FIND HOST” and the Dual TAGGER will scroll www.lazertag.com and then go to sleep. The player now brings the primary TAGGER back to the TAG MASTER TAGGER and is debriefed in the normal manner.

11 PRE-PROGRAMMED LAZER TAG® GAMES

1. CLASSIC LAZER TAG (LTAG)

The object of this game is to be the last player not tagged out. All of the other players are your opponents. It's an aggressive, go-get-em type of game. [TAG12]

Of all the games you can choose to play, Classic LAZER TAG is the only game that has no hosting or joining at the beginning of the game, no debriefing, ranking, or head-to-head comparisons at the end of the game, and has unlimited time to complete the game. Dual TAGGER mode is not allowed in this game and players with Deluxe TAGGER units have up to 12 Mega Tags available for use. Players may enter or leave the game at any time.

Preset game features are:

- Unlimited number of players
- 15 seconds of Shield time allowed
- Unlimited Reloads
- Players are tagged out after taking 10 Tags
- No score ranking – last player NOT tagged out wins
- After being tagged out, the LCD screen will continue to show the game timer running, allowing other players to verify that you did not restart your TAGGER in mid-game. You can use INC and DEC to switch back and forth between this display and a display showing how long you lasted in the game before being tagged out.

2. CUSTOM LAZER TAG (CUST)

The object of this game is to be the last player not tagged out, while scoring as many tags on your opponents as possible. All of the other players are your opponents. [TAG13]

Game feature:

- Up to 24 individual players, each have their own player ID

Scoring:

- Individual ranks are based on earning 2 pts per tag landed on opposing players and losing 1 pt for every time an opposing player tags you.

3. 2-TEAM CUSTOMIZED LAZER TAG (2TMS) AND

4. 3-TEAM CUSTOMIZED LAZER TAG (3TMS)

The object of these games is to have the most number of your team's players remain in the game, while scoring as many tags as possible on opposing players. [TAG78]

Some of the players are on the same team as you, while others are on one or two opposing teams. It is important that you work with your teammates in order to achieve a high team ranking. Do this by helping to protect any of your teammates who are in danger of being tagged out, and working with your teammates to tag the opposing players out as quickly as possible. [TAG11]

Game feature:

- 2 or 3 teams of up to 8 players per team

Scoring:

- Individual ranks are based on earning 2 pts per tag landed on players from an opposing team, and losing 1 pt for every time a player from an opposing team tags you. Tagging your own teammate (Team Tags) costs you 2 pts. Being tagged by your own teammates does not hurt your score.
- Team ranks are based on which team has the most players not tagged out when the game ends (this gives an advantage to larger teams, so less-skilled players can be grouped together on a larger team to even things out). Ties are broken by the TAG MASTER based on the combined scores of the players on each team who did not get tagged out – this rewards the team with the more aggressive players that score more tags. Just hiding or trying to not get tagged may cost your team valuable points that could affect your team's ranking.

5. 2-KINGS (2KNG) AND

6. 3-KINGS (3KNG)

The object of these games is to tag out the opposing team's King while protecting your own King. [TAG21]

The other teams do not always know who the King is on each team; the only clue may be that the King's TAGGER will not send out an IFF signal. This prevents enemy players from locking on to his IFF signal, but also makes it easier for them to determine that he is in fact the King once they do find him. These games may require individual players to sacrifice their own individual ranking for the greater good of the team, this is the nature of the game...protect your King even if it means being tagged out. [TAG62]

The TAG MASTER is always the King of Team 1, and the first player to join each of the other teams is the King of that team. The Kings are fully capable of tagging other players (including other Kings) and defending themselves by raising shields.

NOTE: The Kings cannot request or receive Medic Mode assistance.

Game feature:

- 2 or 3 teams of up to 8 players per team

Scoring:

- Individual ranks are based on the number of tags you have landed on the other Kings. Tagging your own King counts as 4 pts against you.
- Team ranks are based on how long each King lasted before being tagged out. If more than one King lasts until the end of the game, the team whose King took the fewest tags wins.

7. HUNT THE TAG MASTER (TAGM)

The object of this game is for the TAG MASTER to battle against up to 8 of his most feared opponents! The TAG MASTER is alone on Team 1 while his opponents join forces on Team 2 and go for the hits! [TAG07]

The TAG MASTER has the combined amount of all the opponent's reloads and tags, and the same amount of time and shields.

Game feature:

- 1 team of up to 8 players versus: TAG MASTER

Scoring:

- Individual ranks are based on earning 2 pts per tag landed on the TAG MASTER, and losing 1 pt for every time the TAG MASTER tags you. Tagging your own teammate (Team Tags) costs you 2 pts. Being tagged by your own teammates does not hurt your score, but reduces the number of hits remaining until you're out. The TAG MASTER gets 2 pts for every tag landed on an opponent, and loses 1 pt for every tag taken from an opponent.
- Team ranking is based on whether or not the TAG MASTER makes it to the end of the game without being tagged-out. If he does, then Team 1 (the TAG MASTER) takes first place. If he doesn't, then Team 2 (the opponents) takes first place.

NOTE: The TAG MASTER will be ranked individually. Therefore, it is possible for the TAG MASTER to make it to the end of the game (enabling his team to win) and also have the lowest individual score (he could have been tagged a lot, but not out). Or, the TAG MASTER may not have made it to the end of the game (meaning his team lost) but could have the highest individual score if he landed a lot of tags, before he was tagged out.

8. 2 TEAMS VS. THE TAG MASTER (2TTM)

The object of this game is for the TAG MASTER (Team 1) to survive the game and score as many tags as possible on the opponents (Teams 2 and 3). The opponents' goal is to score as many tags as possible on the TAG MASTER to tag him out. See which team can land the most tags on the TAG MASTER! [TAG86]

Both teams need to cooperate with each other to hunt the TAG MASTER, but they also need to try to weaken each other enough so that the other team cannot take first place. It's in the interest of the TAG MASTER to stir up discord between the two opposing teams so that they won't cooperate enough to defeat him.

The TAG MASTER has half the amount of reloads and tags of all of the opponents combined, and the same amount of time and shields as each of the opponents.

Game feature:

- 2 teams of up to 8 players each versus: TAG MASTER

Scoring:

- The individual rank of the TAG MASTER is based on earning 2 pts per tag landed on the opponents and losing 1 pt for every time the opponents land a tag on him. The individual ranks of the opponents are based on earning 2 pts per tag landed on the TAG MASTER and losing 1 pt for every time the TAG MASTER tags them. Tagging your own teammate (Team Tags) costs you 2 pts. Being tagged by your own teammates does not hurt your score. Tagging a player on the other team or being tagged by them does not affect your rank.

NOTE: All players, except for the TAG MASTER, can use the DUAL TAGGER mode.

- Team ranks are based on whether or not the TAG MASTER makes it to the end of the game without being tagged-out. If he does, then his team (Team 1) takes first place. If he doesn't, then Team 1 takes last place. Teams 2 and 3 are then ranked against each other based on the combined scores of their players. Ties are broken based on the number of players who made it to the end of the game without being tagged-out.

NOTE: The TAG MASTER will be ranked individually. Therefore, it is possible for the TAG MASTER to make it to the end of the game (enabling his team to win) and also have the lowest individual score (he could have been tagged a lot, but not out). Or, the TAG MASTER may not have made it to the end of the game (meaning his team lost) but could have the highest individual score if he landed a lot of tags, before he was tagged out.

9. TAG MASTER VS. INDIVIDUAL PLAYERS (TMIG)

The object of this game is for the TAG MASTER (Player 1) to survive the game and score as many tags as possible on the opponents (Players 2-24). The opponent's goal is to tag-out the TAG MASTER before the game ends. [TAG25]

The TAG MASTER has half the amount of reloads and tags of all of the opponents combined, and the same amount of time and shields as each of the opponents.

HINTS: Form alliances before the start of the game in order to defeat the TAG MASTER - but don't trust your allies too much – they want to take first place as much as you do! The TAG MASTER should try to keep the opponents at a distance and start battles between the opponents, so that they waste resources and weaken each other.

Game feature:

- Up to 23 individual players versus: TAG MASTER

Scoring:

- Individual ranks for the opponents are based on earning 2 pts per tag landed on the TAG MASTER, and losing 1 pt for every time the TAG MASTER tags you (tagging or being tagged by the other opponents does not affect your rank.) Individual rank for the TAG MASTER is based on receiving 2 pts per tag landed on the opponents, and losing 1 pt for every time the opponents tag him.

NOTE: All players, except for the TAG MASTER, can use the DUAL TAGGER mode.

10. 1-ON-1 (1ON1)

The object of the game is to score as many tags as possible on the opposing team's player who has the same Player ID number as you. For example, if you're Player 2 on Team 1, then Player 2 on Team 2 is your "principal opponent" and you get a much higher score for landing tags on that player than you do for tagging other players on his team. [TAG02]

NOTE: Swapping TAGGER units to fool your opponents is not allowed. If you do this your team forfeits the game.

Game feature:

- 2 teams of up to 8 players each
- One opponent counts for more than the others

Scoring:

- Individual ranks are based on earning 1 pt per tag landed on most players from the other team, or 5 pts if that player is your principal opponent. You lose 1 pt for every time a player from the other team tags you, whether it is your principal opponent or one of the other opponents. Tagging your own teammate (Team Tags) costs you 2 pts. Being tagged by your own teammates does not hurt your score.
- Team ranks are based on the combined scores of all players in the game. Ties are broken based on the number of players on each team who made it to the end of the game.

11. SURVIVAL (SURV)

The object of this game is to be the last player not tagged out, while scoring as many tags against your opponents as possible. In this game, all other players are your opponents and it's every player for his or herself. Win the game by lasting the longest and scoring the most tags on your opponents. [TAG16]

This game includes a limit on how rapidly you will take tags from other players. You can only be tagged at a rate of roughly 1 tag every other second. You can LAUNCH tags as rapidly as you like, but after the first one lands on an opponent, any rapidly following tags will be wasted.

HINT: Stay hidden while locating your opponents and tag them just enough to make them move so that they get tagged by other players. [TAG47]

Game feature:

- Up to 24 individual players
- Slow Tags
- Survival time counts for points

Scoring:

- Individual ranks are based on earning 10 pts for every full minute of the game that you are not tagged out plus 2 pts per tag landed on any other players. You lose 1 pt for every time a player tags you.

TROUBLESHOOTING

IMPORTANT NOTE: If your TAGGER is functioning improperly or stops functioning, try pressing the Reset Button.

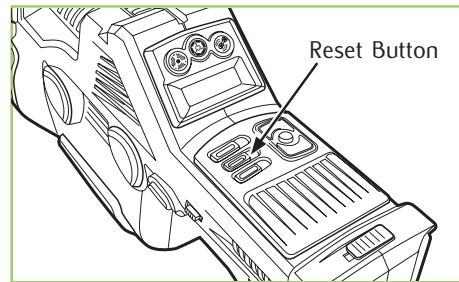

Build the Ultimate LAZER TAG System!

The Deluxe 1 Player
System is also available
in green camouflage!

DELUXE 1 PLAYER SYSTEM

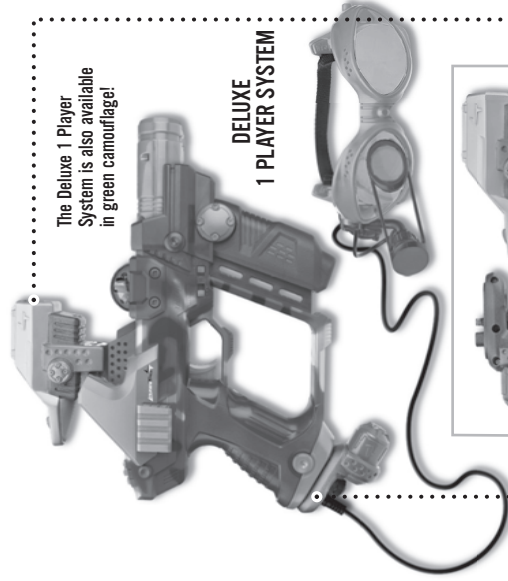

2 PACK ACCESSORY KIT

Accessorize any
LAZER TAG TAGGER
with the Virtual Scope™
and Thunder Pack™!



IRT-2X TAGGER™*

IRT-2X TAGGER is also
available in green!

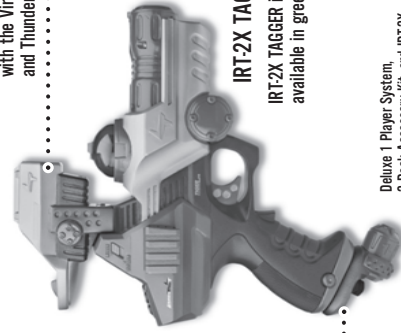

Deluxe 1 Player System,
2 Pack Accessory Kit, and IRT-2X
Tagger each sold separately.

FCC STATEMENT

This equipment has been tested and found to comply with the limits for a Class B digital device, pursuant to part 15 of the FCC Rules. These limits are designed to provide reasonable protection against harmful interference in a residential installation. This equipment generates, uses and can radiate radio frequency energy, and, if not installed and used in accordance with the instructions, may cause harmful interference to radio communications. However, there is no guarantee that interference will not occur in a particular installation. If this equipment does cause harmful interference to radio or television reception, which can be determined by turning the equipment off and on, the user is encouraged to try to correct the interference by one or more of the following measures:

- Reorient or relocate the receiving antenna.
- Increase the separation between the equipment and the receiver.
- Consult the dealer or an experienced radio/TV technician for help.

Changes or modifications to this unit not expressly approved by the party responsible for compliance could void the user's authority to operate the equipment.

Lazer Tag is a trademark of Shoot the Moon Products and used with permission.

Energizer, Energizer MAX and other marks are trademarks of Eveready Battery Company, Inc.

®* and/or TM* & © 2005 Hasbro. All Rights Reserved.
TM & ® denote U.S. Trademarks.

U.S. Patent No. 5904621 and Patent Pending.
75066 P/N 6530190000

Product and colors may vary.



TIGER
ELECTRONICS^{®*}

Where Technology Comes to Play!^{TM**}

CHECK OUT ONLINE GAMES AND TIPS AT
www.LAZERTAG.com

Questions? Call 1-800-844-3733